

5/25/10

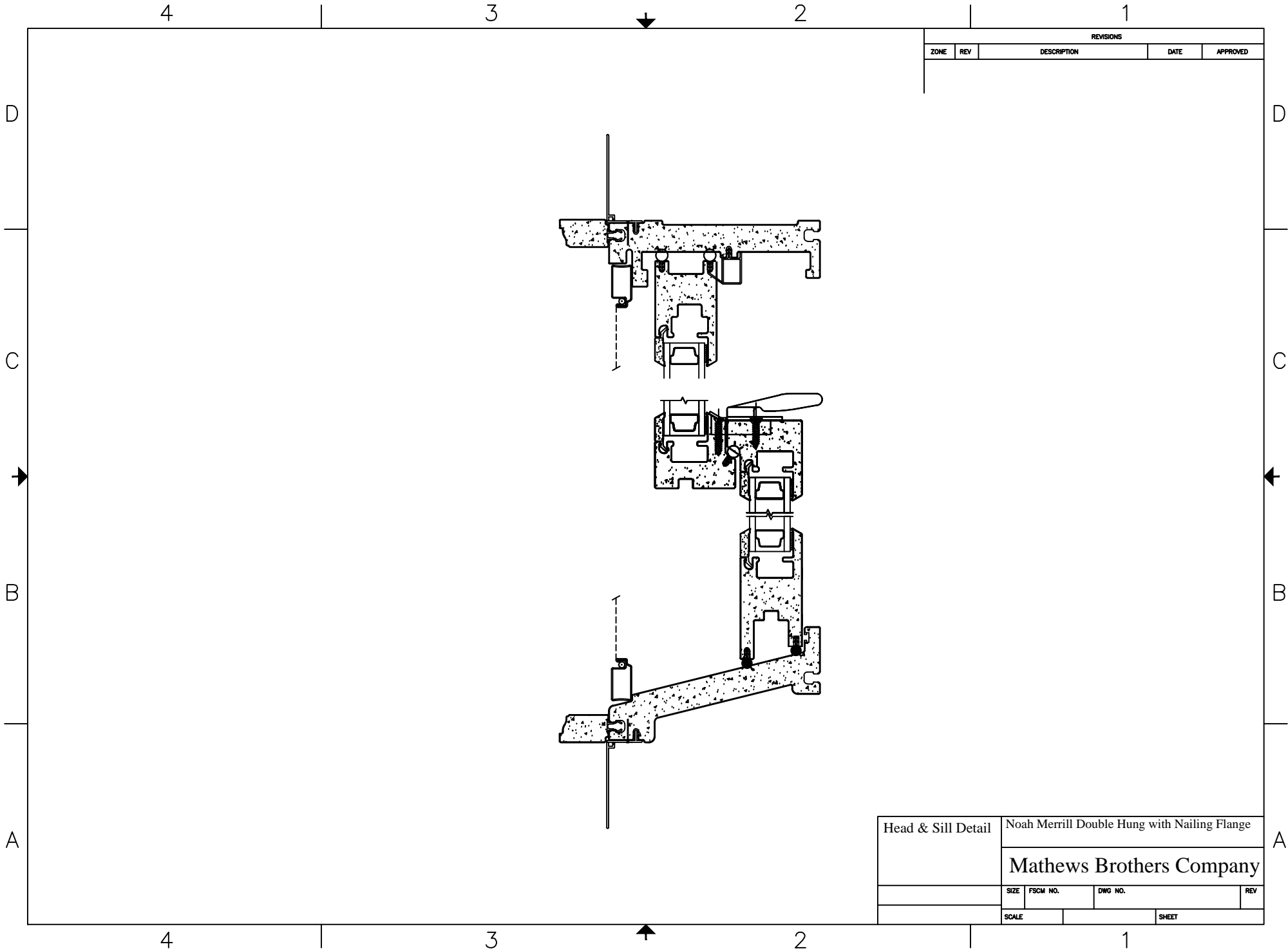

REVISIONS				
ZONE	REV	DESCRIPTION	DATE	APPROVED

Head & Sill Detail	Noah Merrill Double Hung with Nailing Flange			
	Mathews Brothers Company			
	SIZE	FSCM NO.	DWG NO.	REV
	SCALE		SHEET	

5/25/10

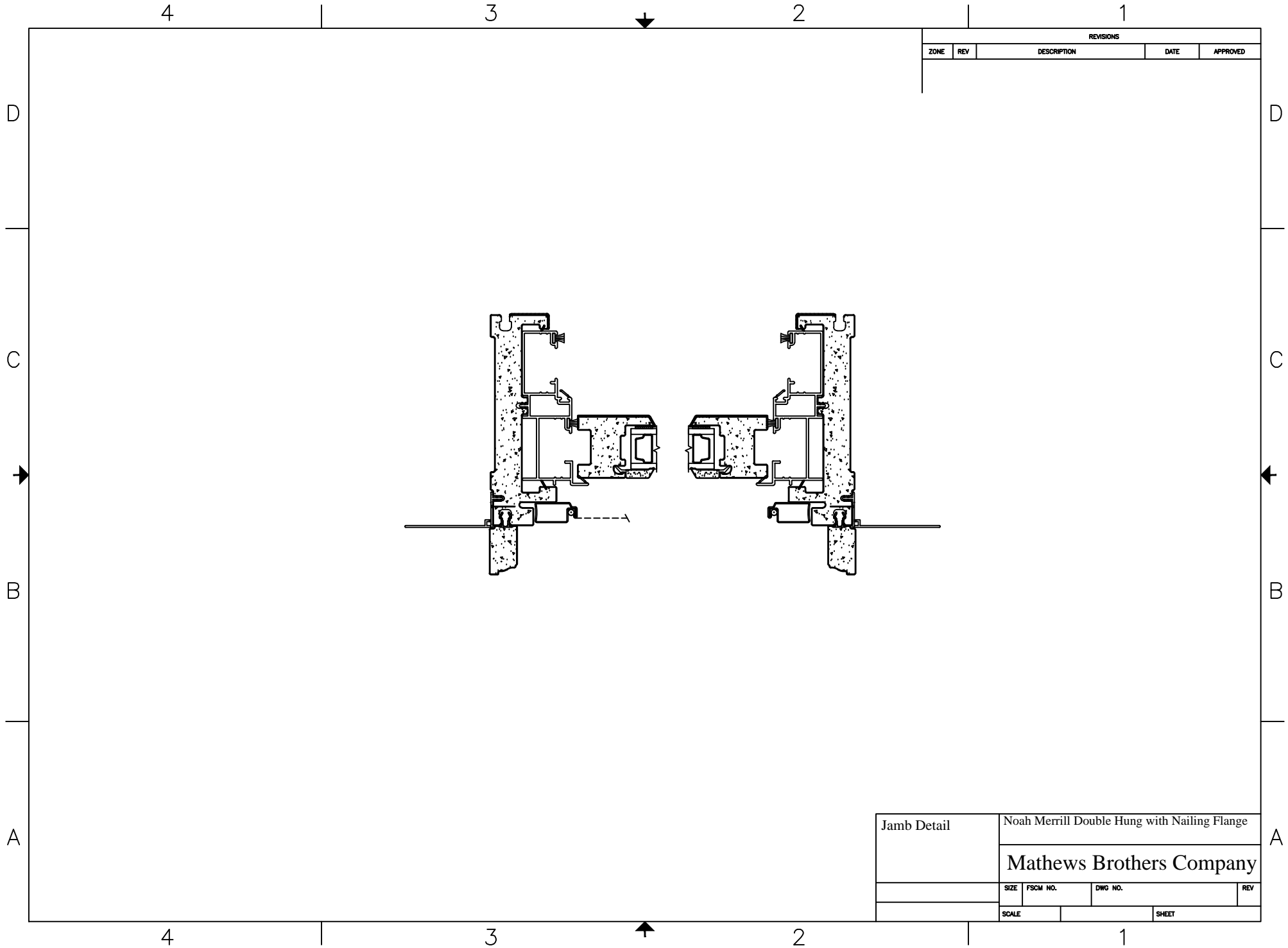

REVISIONS				
ZONE	REV	DESCRIPTION	DATE	APPROVED

Jamb Detail	Noah Merrill Double Hung with Nailing Flange			
	Mathews Brothers Company			
	SIZE	FSCM NO.	DWG NO.	REV
	SCALE		SHEET	

5/25/10

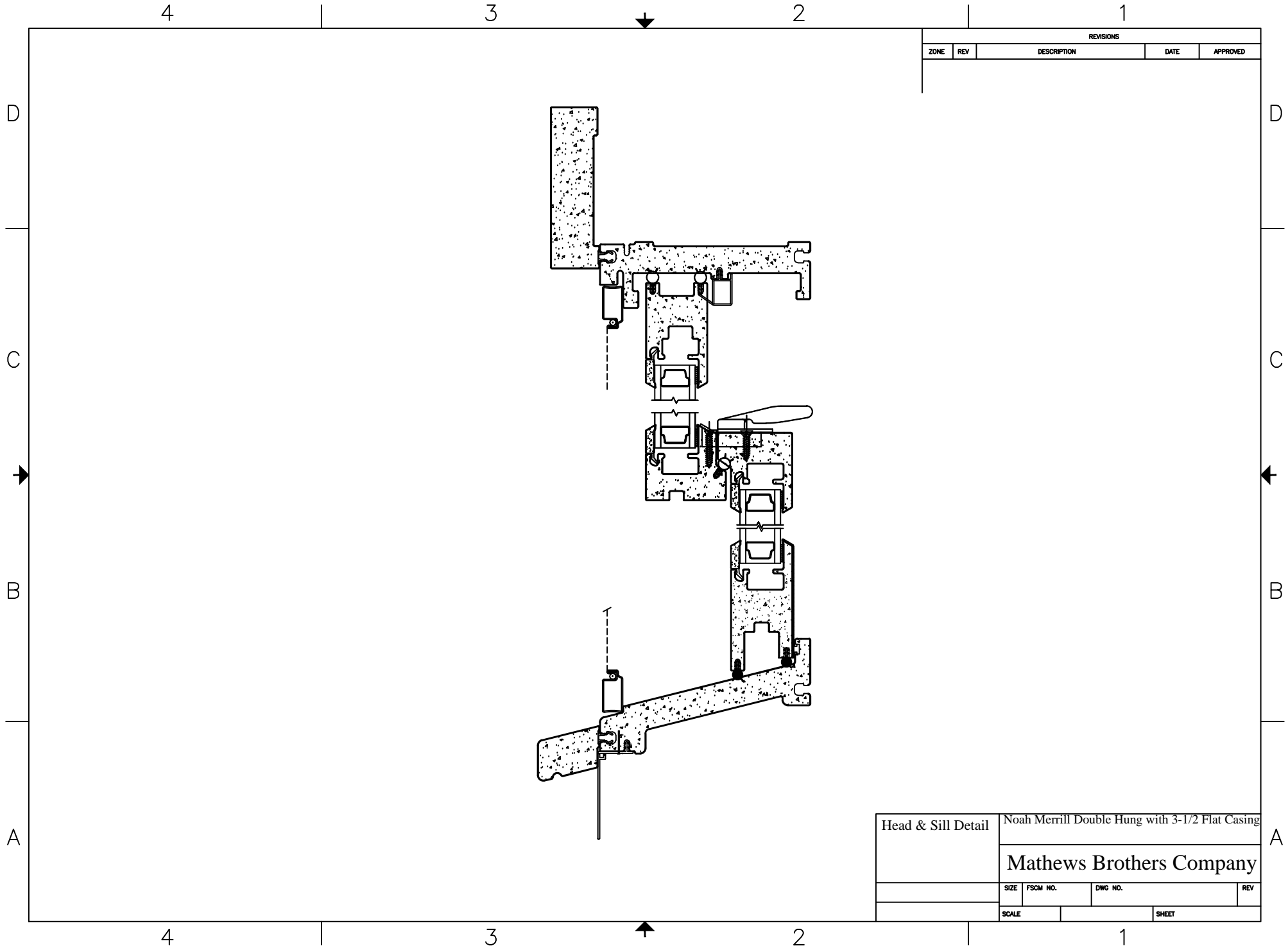

REVISIONS				
ZONE	REV	DESCRIPTION	DATE	APPROVED

Head & Sill Detail	Noah Merrill Double Hung with 3-1/2 Flat Casing			
	Mathews Brothers Company			
	SIZE	FSCM NO.	DWG NO.	REV
	SCALE		SHEET	

5/25/10

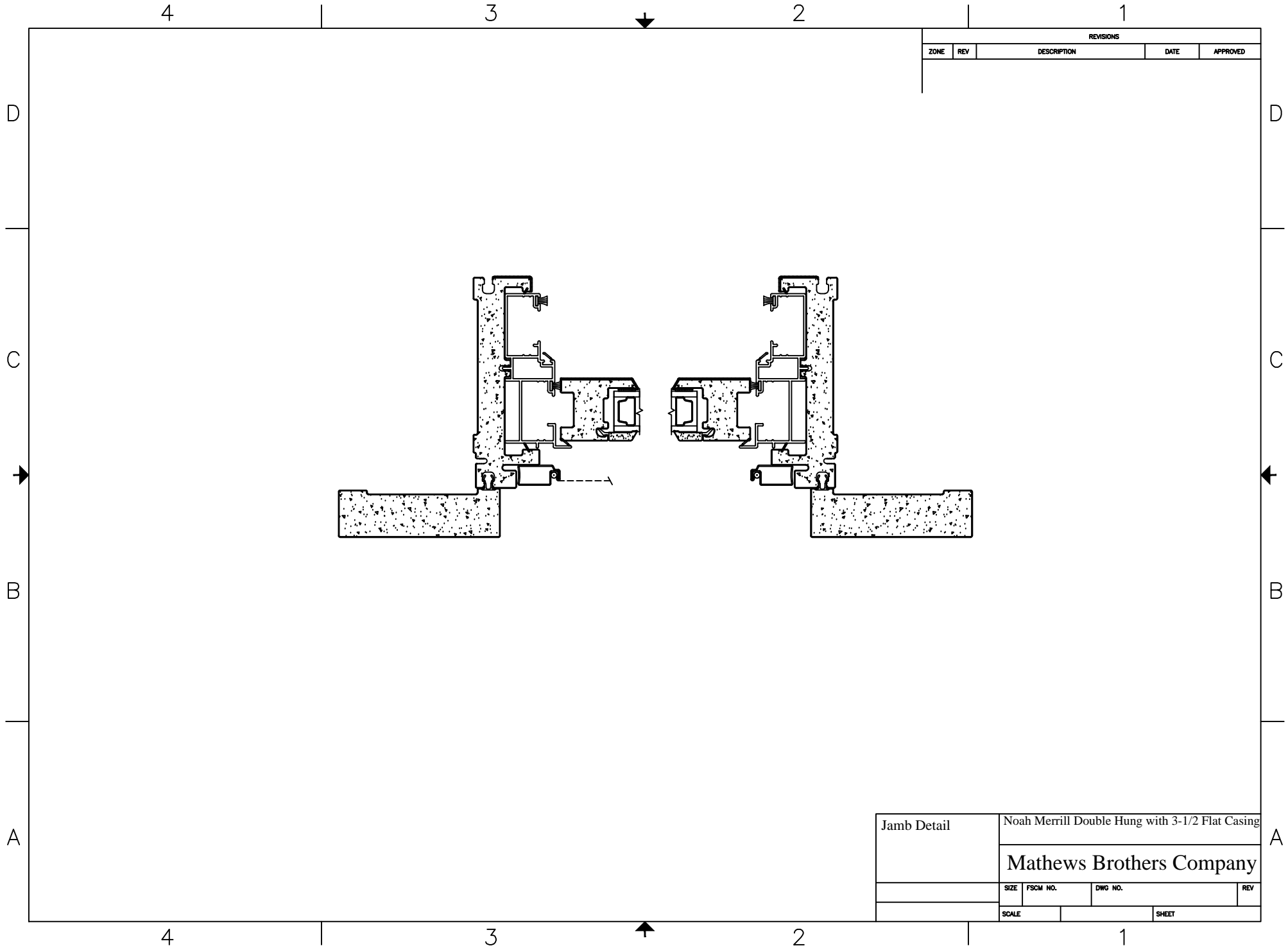

REVISIONS				
ZONE	REV	DESCRIPTION	DATE	APPROVED

Jamb Detail	Noah Merrill Double Hung with 3-1/2 Flat Casing			
	Mathews Brothers Company			
	SIZE	FSCM NO.	DWG NO.	REV
	SCALE		SHEET	

5/25/10

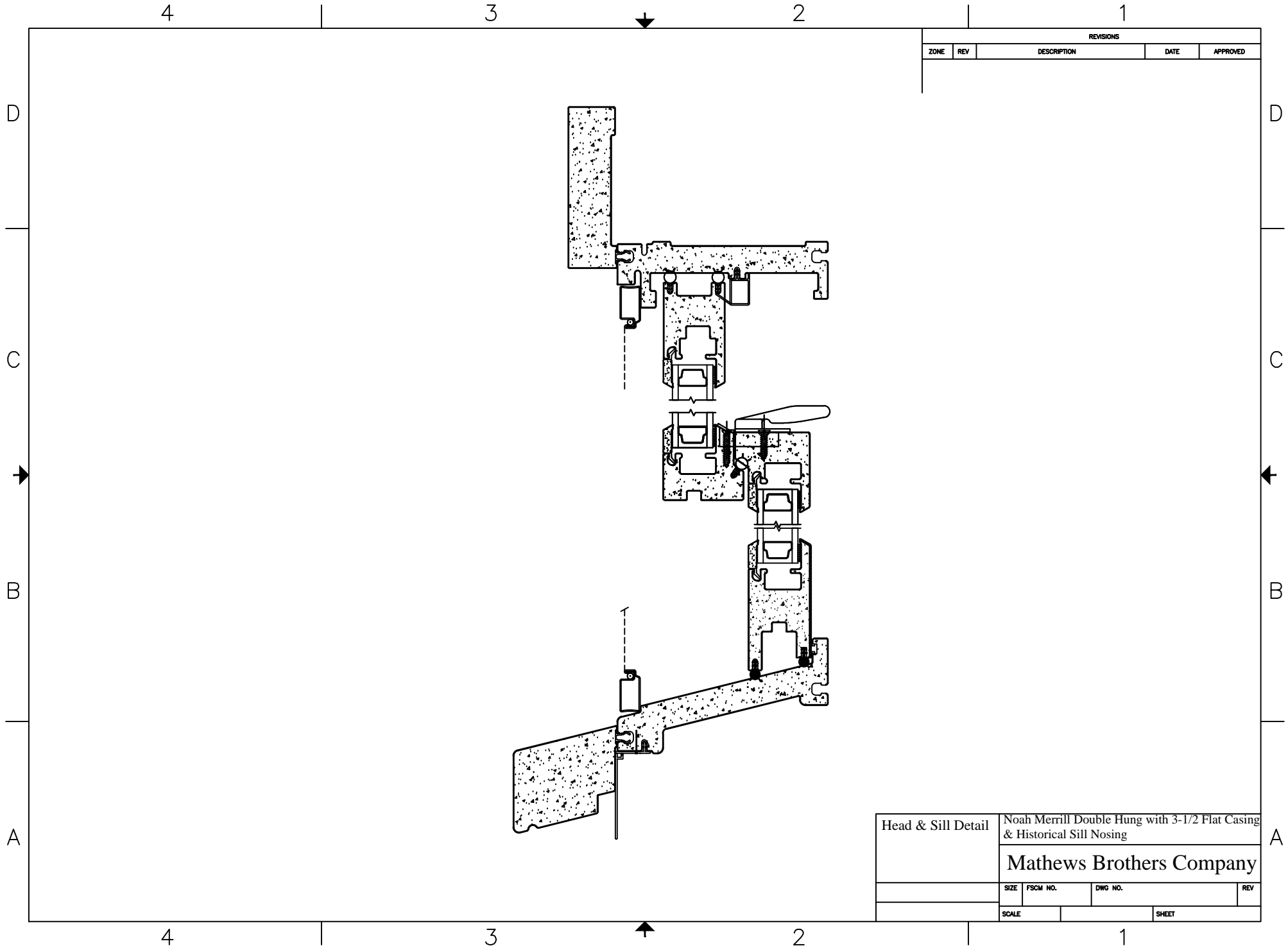

REVISIONS				
ZONE	REV	DESCRIPTION	DATE	APPROVED

Head & Sill Detail	Noah Merrill Double Hung with 3-1/2 Flat Casing & Historical Sill Nosing			
	Mathews Brothers Company			
	SIZE	FSCM NO.	DWG NO.	REV
	SCALE		SHEET	

5/25/10

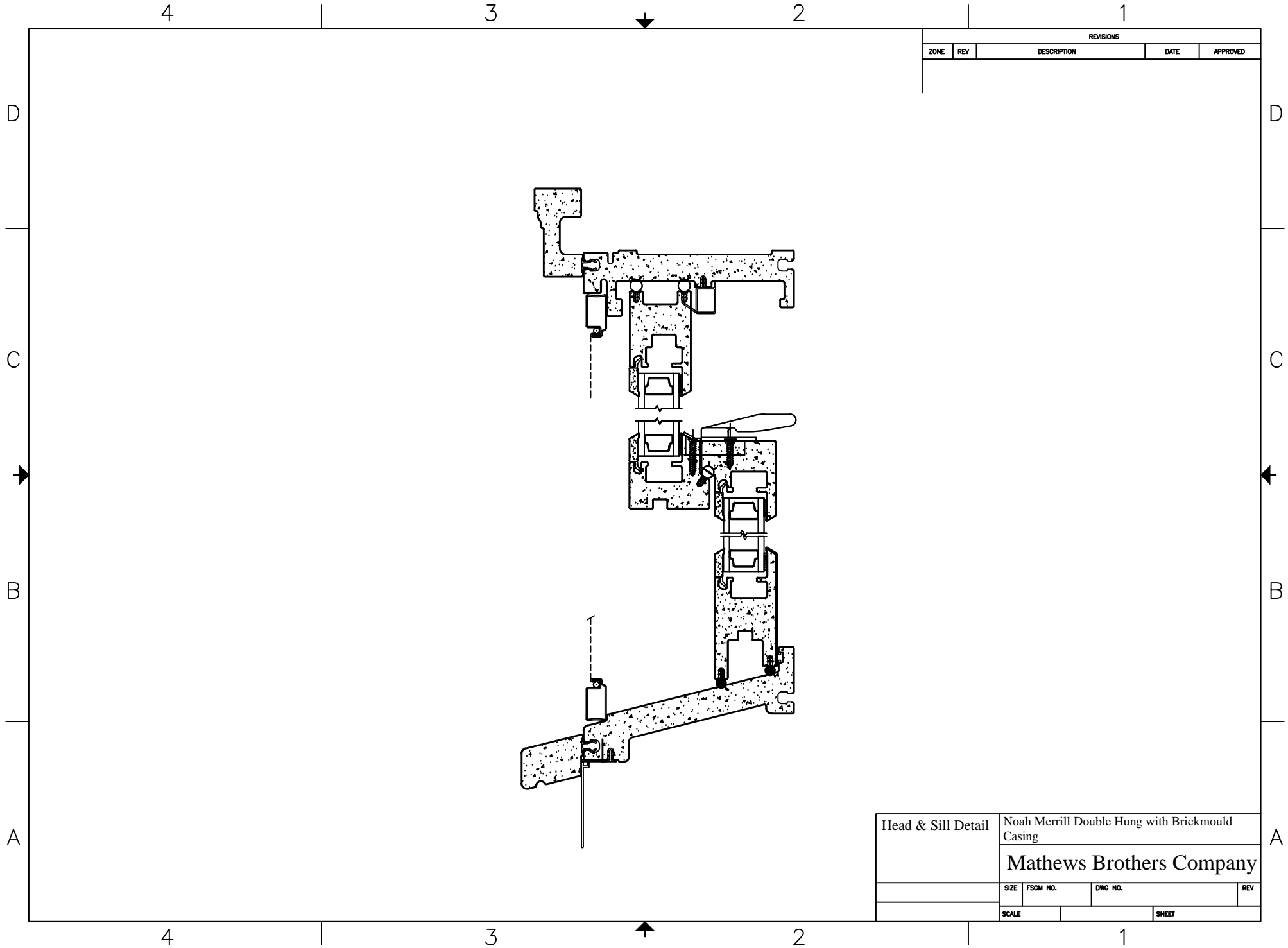

REVISIONS				
ZONE	REV	DESCRIPTION	DATE	APPROVED

Head & Sill Detail	Noah Merrill Double Hung with Brickmould Casing			
	Mathews Brothers Company			
	SIZE	FSCM NO.	DWG NO.	REV
	SCALE		SHEET	

5/25/10

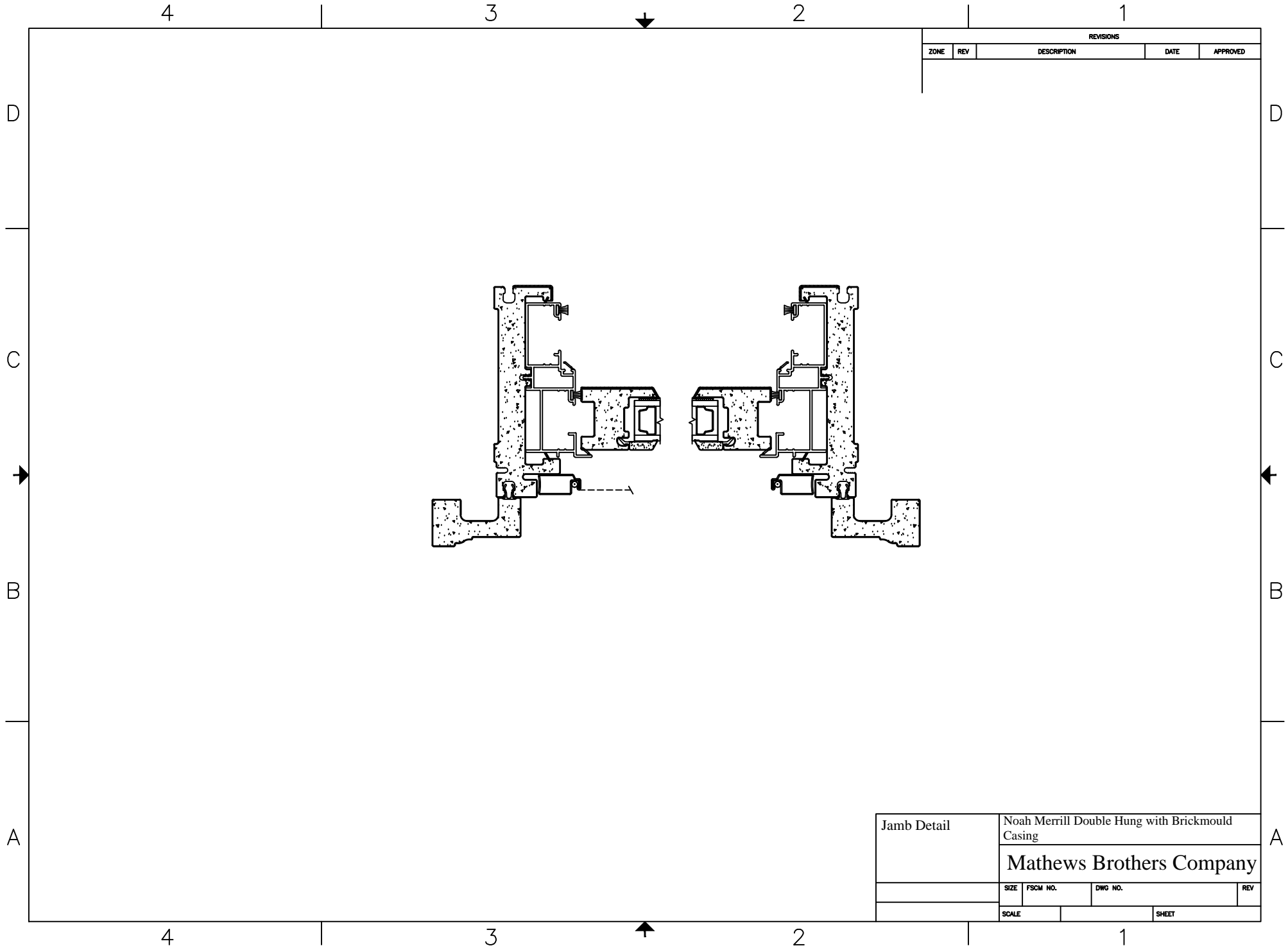

REVISIONS				
ZONE	REV	DESCRIPTION	DATE	APPROVED

Jamb Detail	Noah Merrill Double Hung with Brickmould Casing			
	Mathews Brothers Company			
	SIZE	FSCM NO.	DWG NO.	REV
	SCALE		SHEET	

5/25/10

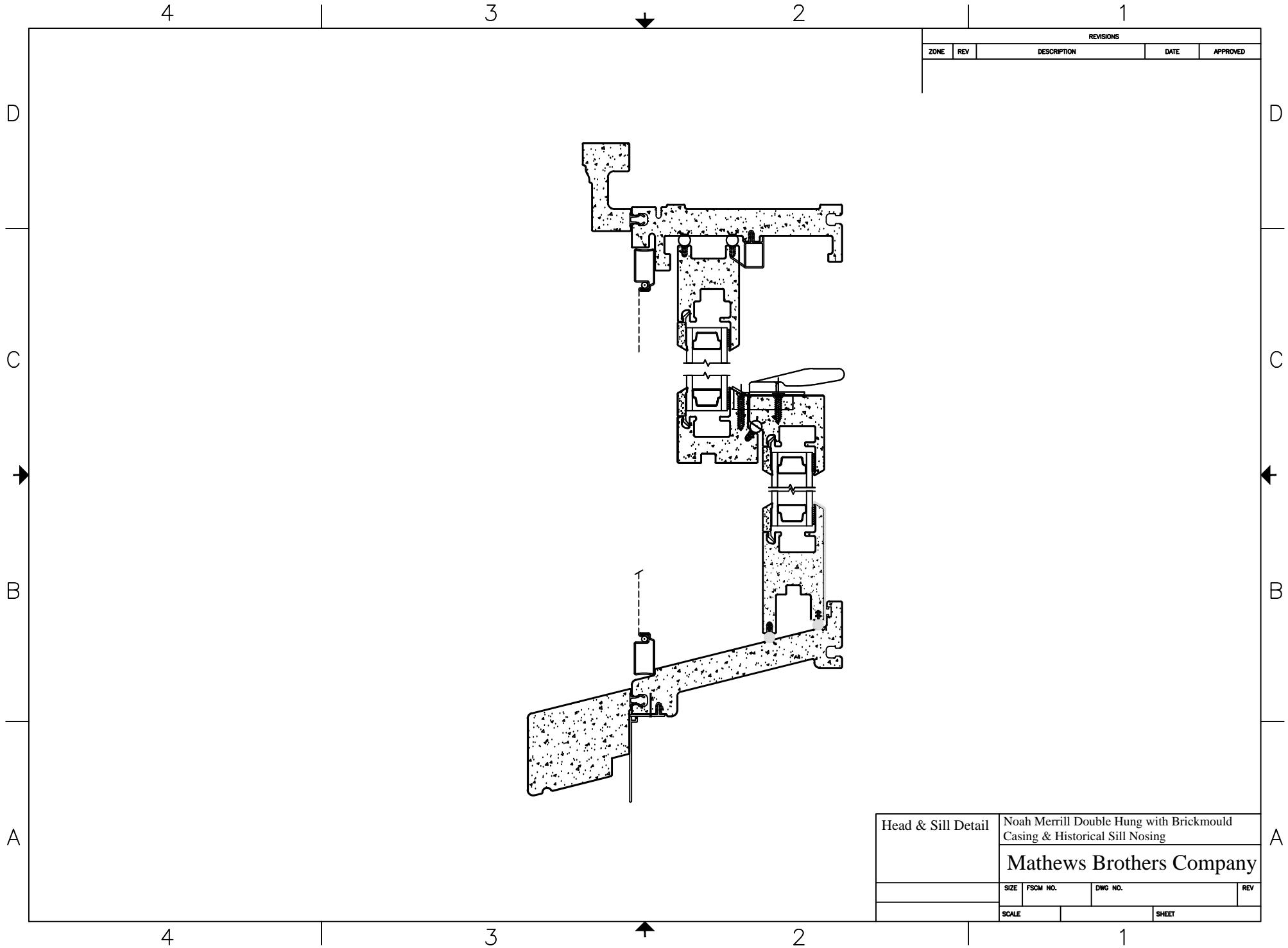

REVISIONS				
ZONE	REV	DESCRIPTION	DATE	APPROVED

Head & Sill Detail	Noah Merrill Double Hung with Brickmould Casing & Historical Sill Nosing			
	Mathews Brothers Company			
	SIZE	FSCM NO.	DWG NO.	REV
	SCALE		SHEET	

5/25/10

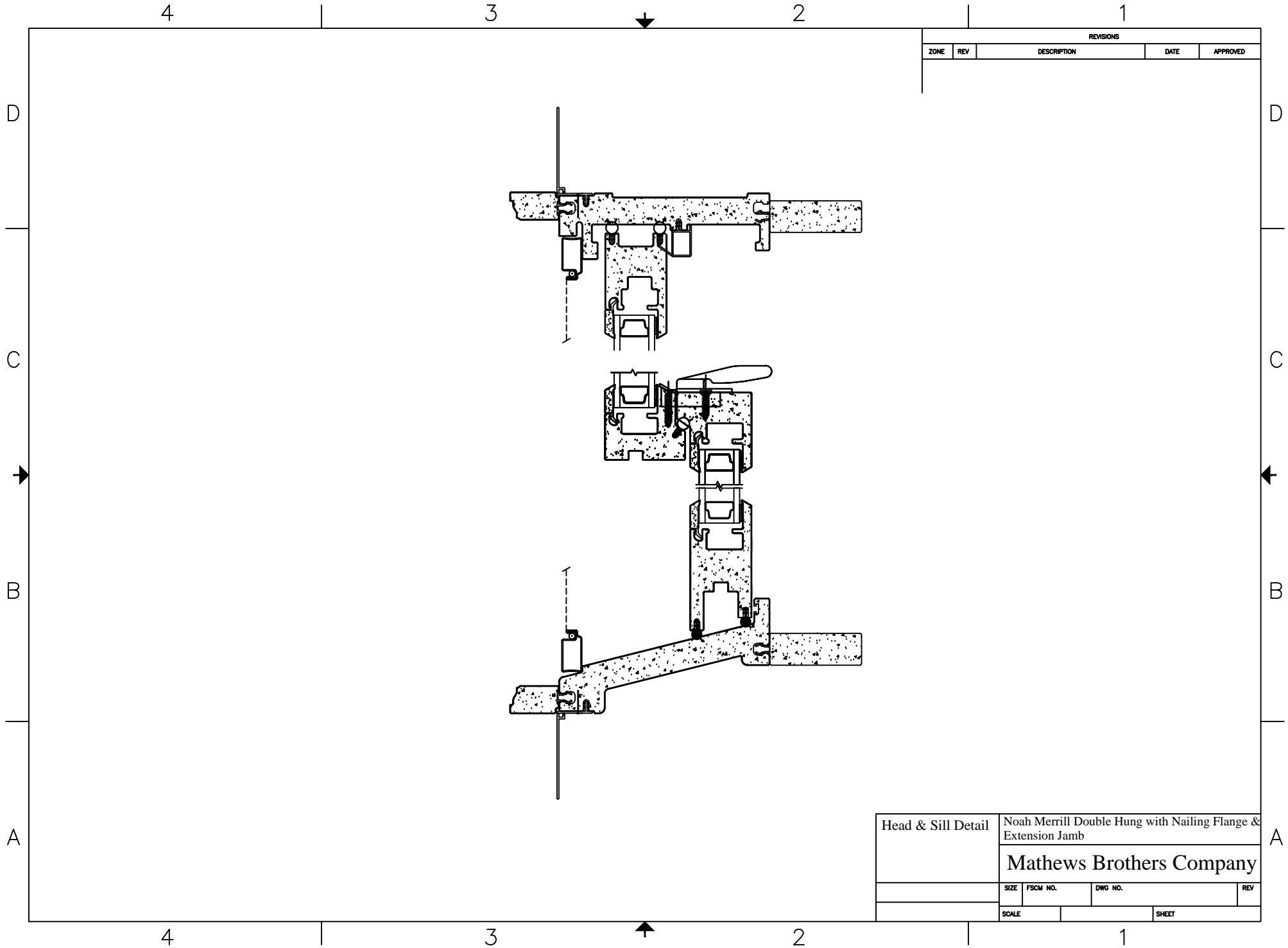

REVISIONS				
ZONE	REV	DESCRIPTION	DATE	APPROVED

Head & Sill Detail	Noah Merrill Double Hung with Nailing Flange & Extension Jamb			
	Mathews Brothers Company			
	SIZE	FSCM NO.	DWG NO.	REV
	SCALE		SHEET	

4

3

2

1

REVISIONS				
ZONE	REV	DESCRIPTION	DATE	APPROVED

D

D

C

C

B

B

A

A

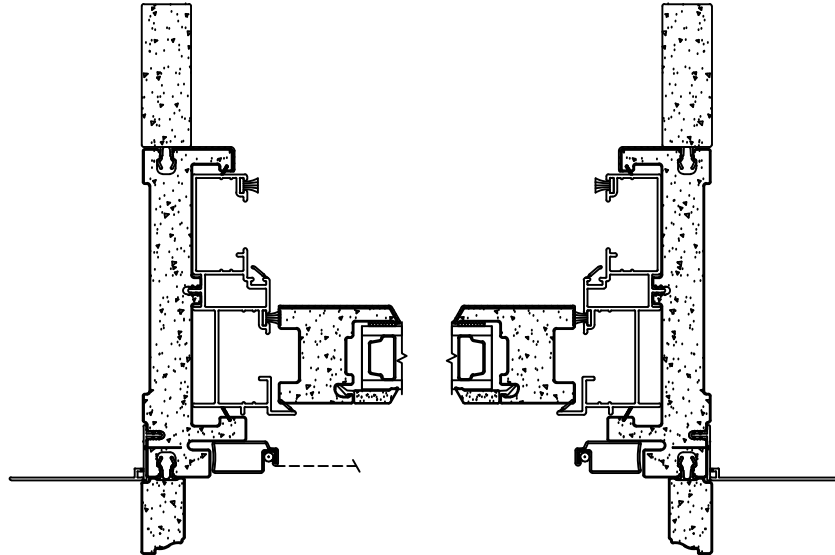

5/25/10

Jamb Detail	Noah Merrill Double Hung with Nailing Flange & Extension Jamb			
	Mathews Brothers Company			
	SIZE	FSCM NO.	DWG NO.	REV
	SCALE			SHEET

4

3

2

1

5/25/10

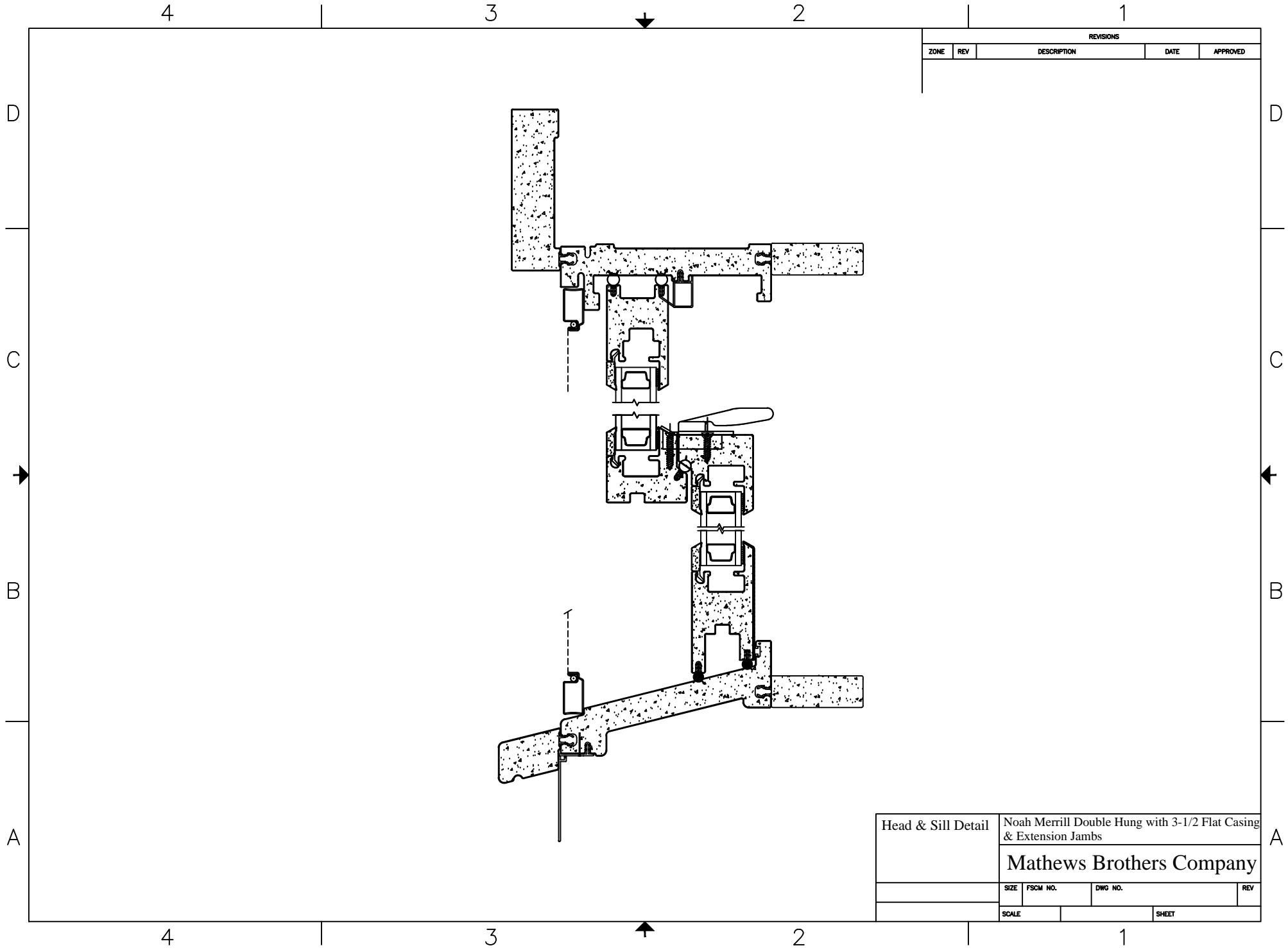

REVISIONS				
ZONE	REV	DESCRIPTION	DATE	APPROVED

Head & Sill Detail	Noah Merrill Double Hung with 3-1/2 Flat Casing & Extension Jambs			
	Mathews Brothers Company			
	SIZE	FSCM NO.	DWG NO.	REV
	SCALE		SHEET	

5/25/10

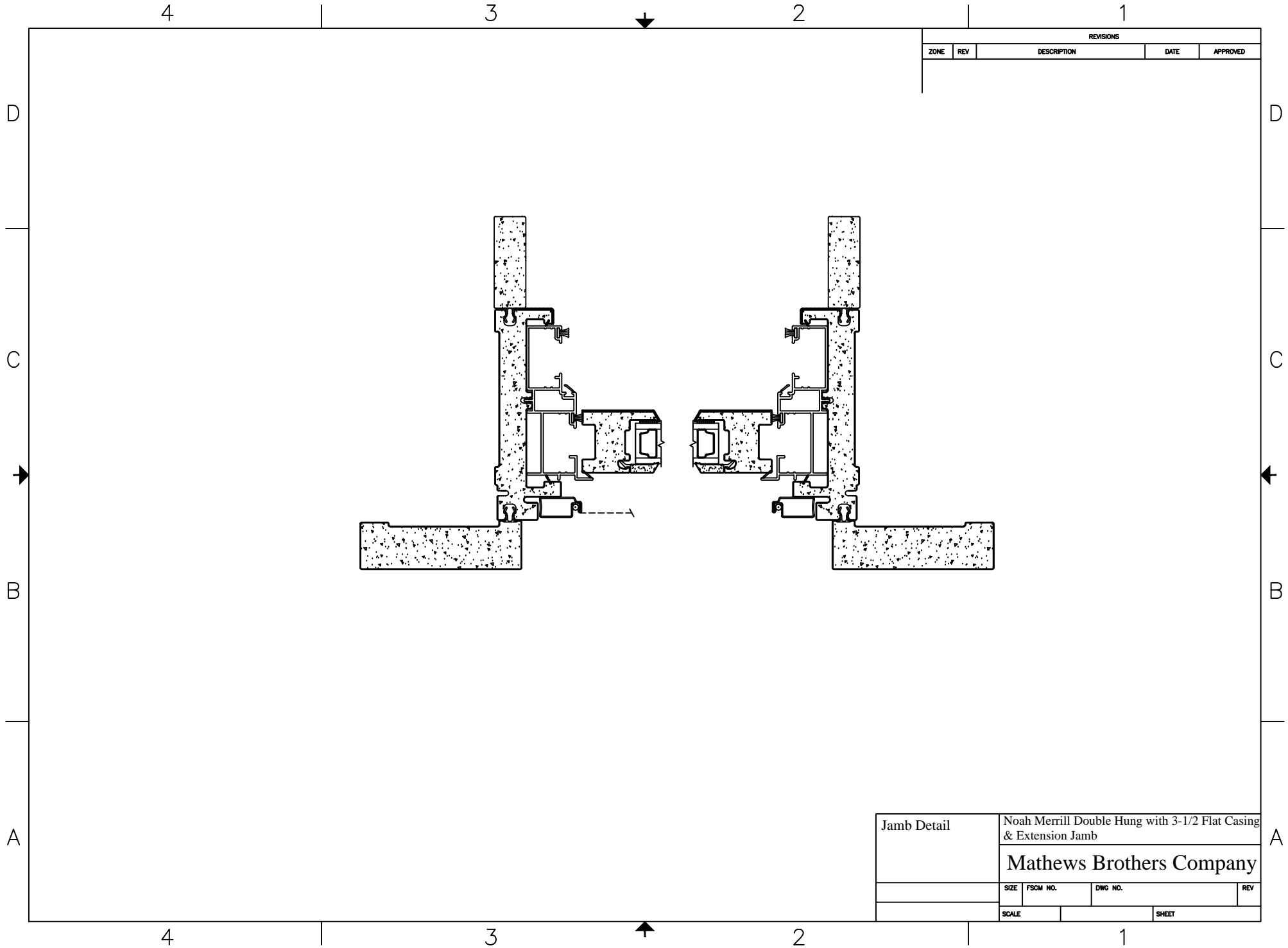

REVISIONS				
ZONE	REV	DESCRIPTION	DATE	APPROVED

Jamb Detail	Noah Merrill Double Hung with 3-1/2 Flat Casing & Extension Jamb			
	Mathews Brothers Company			
	SIZE	FSCM NO.	DWG NO.	REV
	SCALE		SHEET	

5/25/10

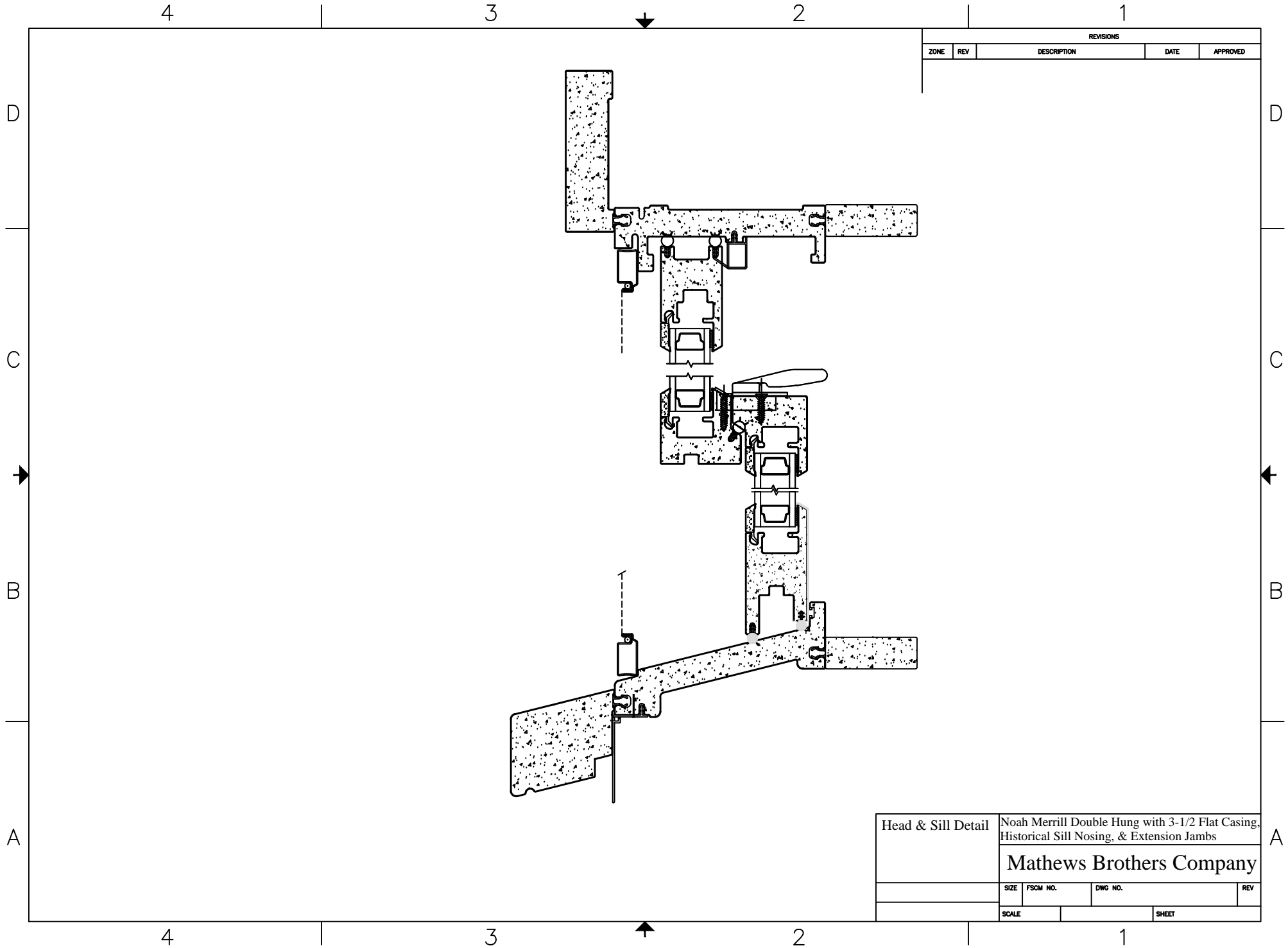

REVISIONS				
ZONE	REV	DESCRIPTION	DATE	APPROVED

Head & Sill Detail	Noah Merrill Double Hung with 3-1/2 Flat Casing, Historical Sill Nosing, & Extension Jamb			
	Mathews Brothers Company			
	SIZE	FSCM NO.	DWG NO.	REV
	SCALE		SHEET	

5/25/10

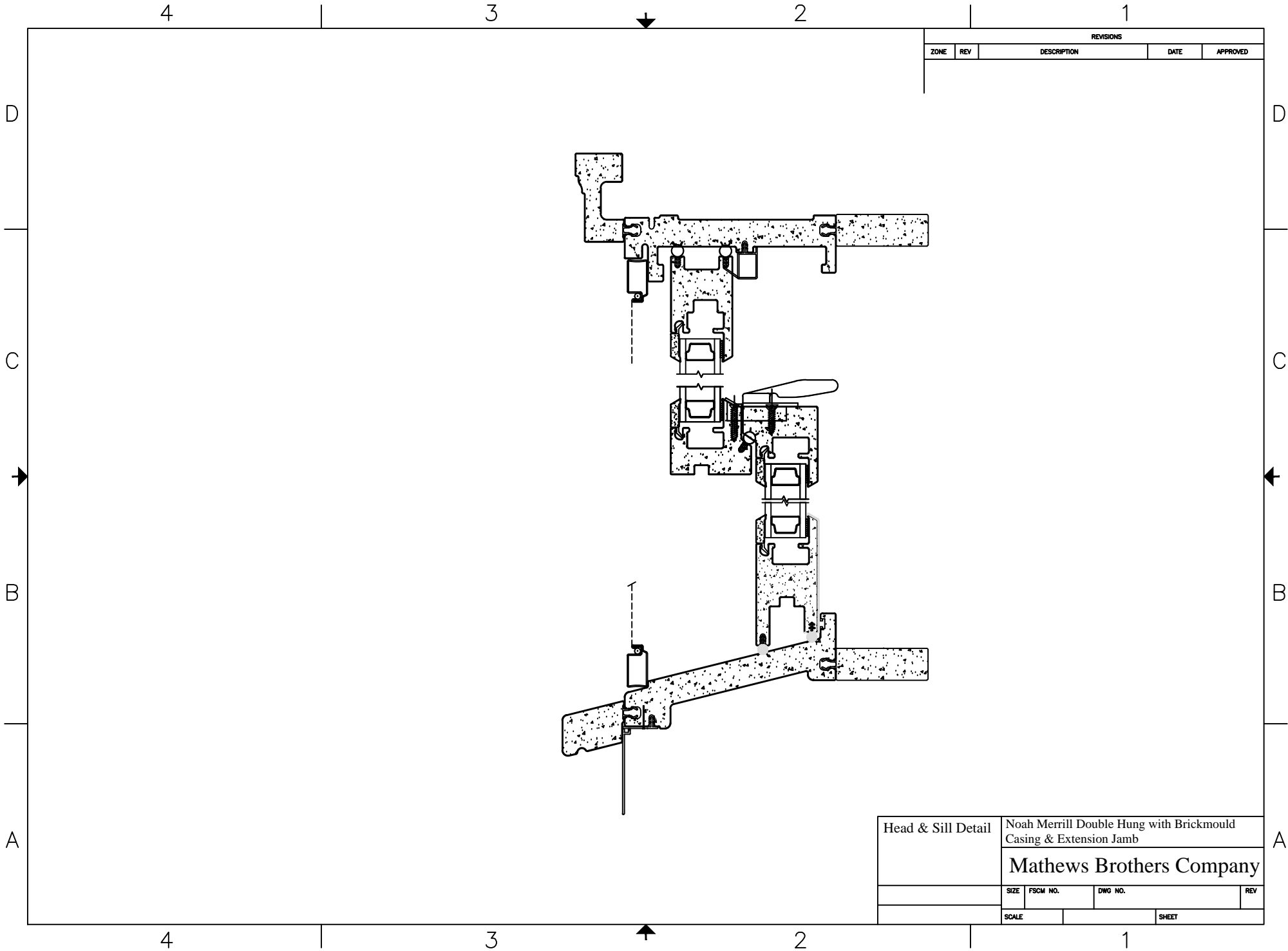

REVISIONS				
ZONE	REV	DESCRIPTION	DATE	APPROVED

Head & Sill Detail	Noah Merrill Double Hung with Brickmould Casing & Extension Jamb			
	Mathews Brothers Company			
	SIZE	FSCM NO.	DWG NO.	REV
	SCALE		SHEET	

5/25/10

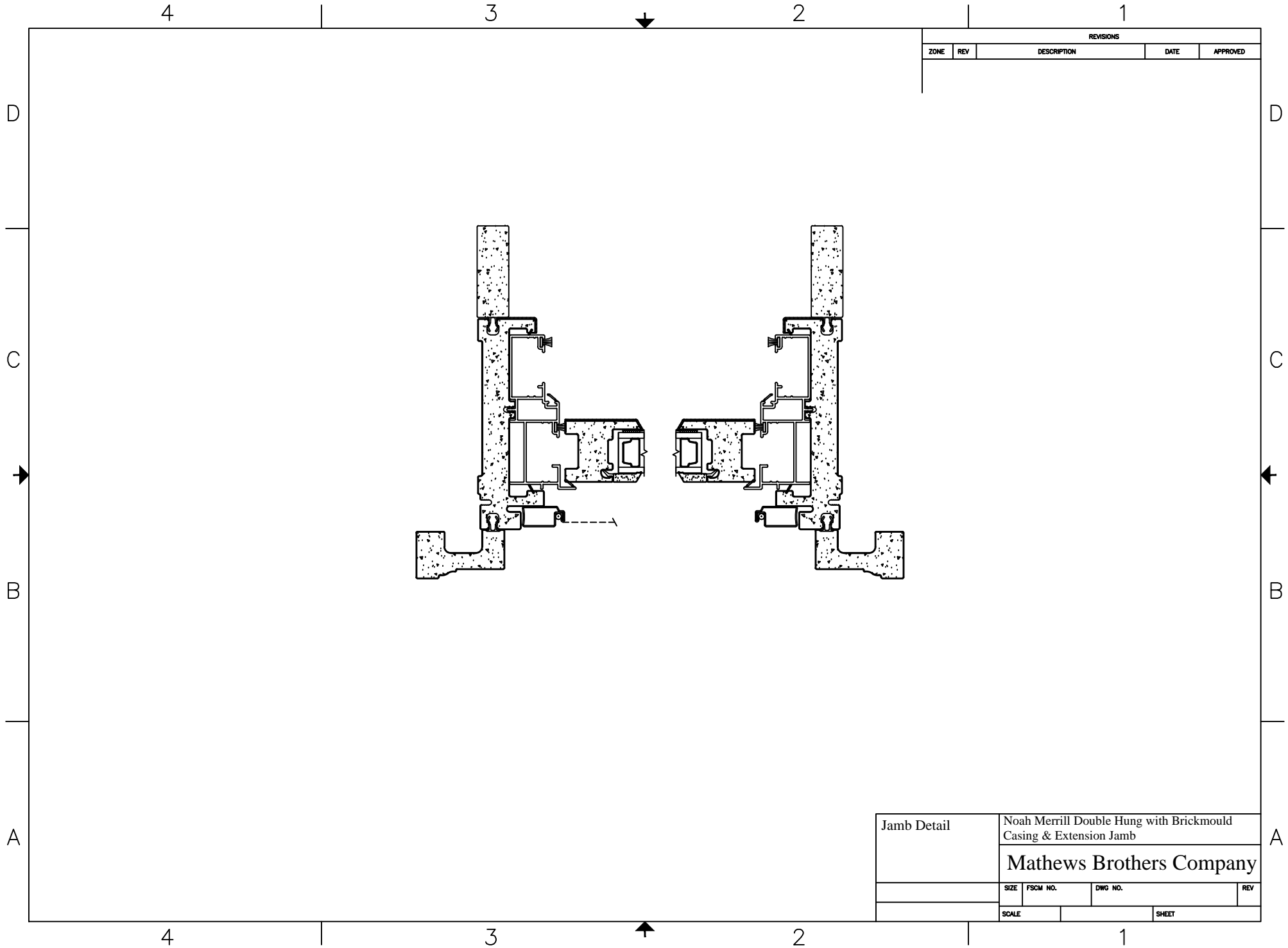

REVISIONS				
ZONE	REV	DESCRIPTION	DATE	APPROVED

Jamb Detail	Noah Merrill Double Hung with Brickmould Casing & Extension Jamb			
	Mathews Brothers Company			
	SIZE	FSCM NO.	DWG NO.	REV
	SCALE		SHEET	

5/25/10

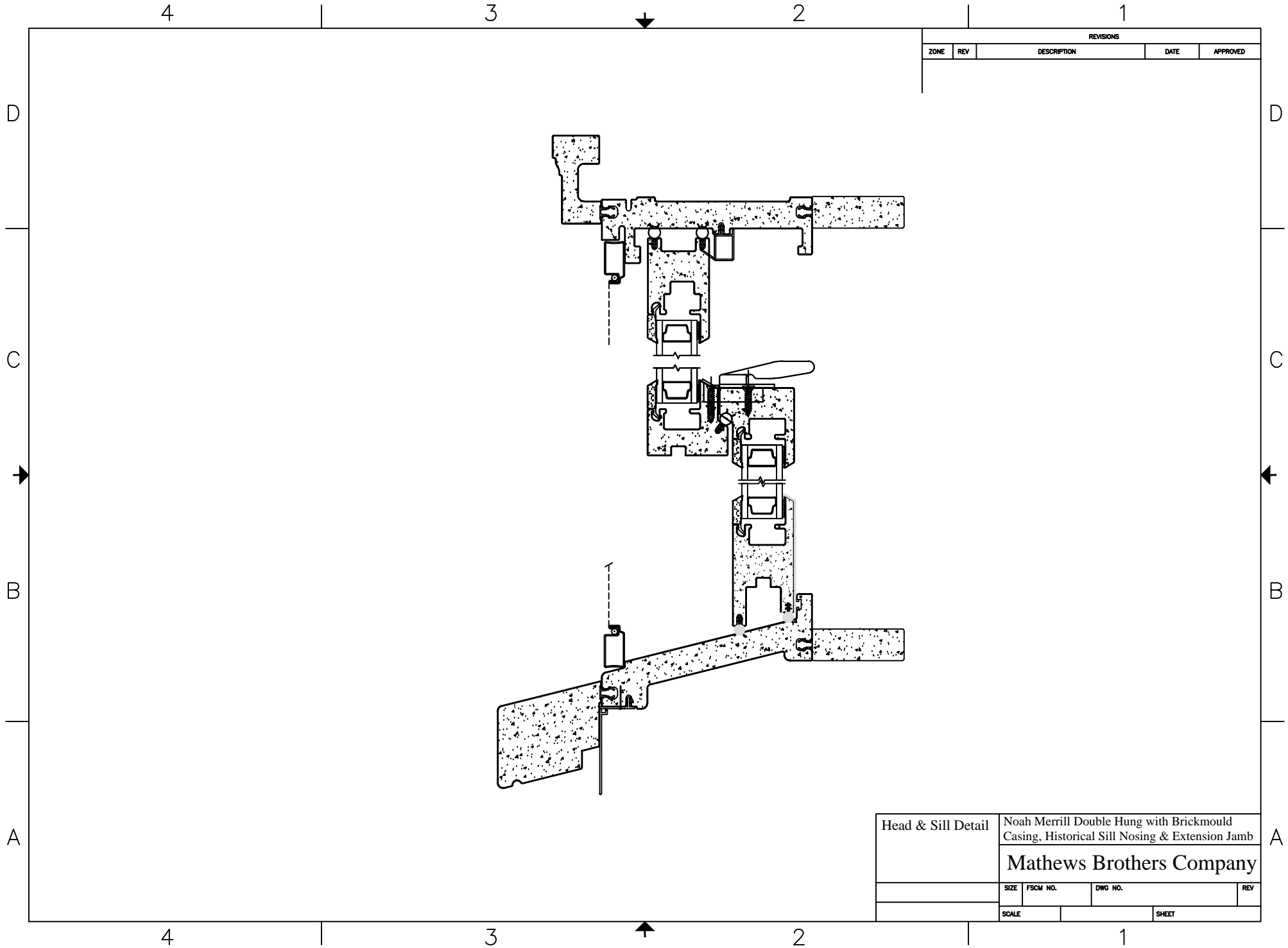

REVISIONS				
ZONE	REV	DESCRIPTION	DATE	APPROVED

Head & Sill Detail	Noah Merrill Double Hung with Brickmould Casing, Historical Sill Nosing & Extension Jamb			
	Mathews Brothers Company			
	SIZE	FSCM NO.	DWG NO.	REV
	SCALE		SHEET	