

Mathews Brothers
Company

--	--	--	--	--

		DESCRIPTION: Walcott New Construction Casement (Left Hand Vent from Exterior Shown)		
"A"				DATE: May 10, 2018
SHEET:	DRAWN BY:	SCALE:		DWG NO.:

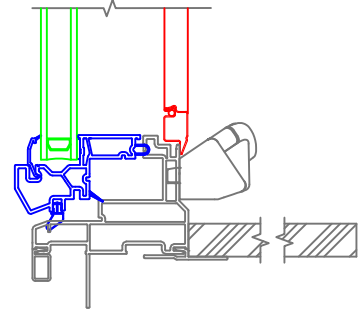
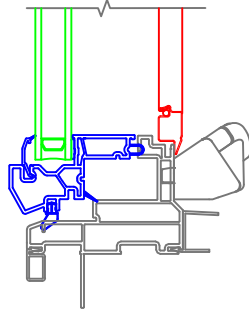
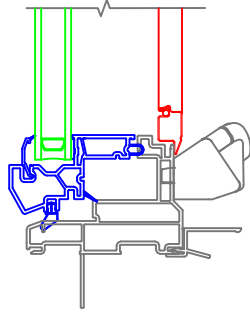
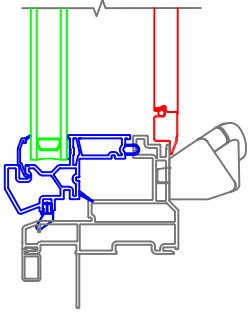
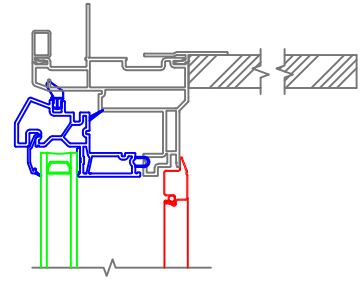
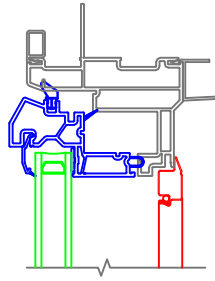
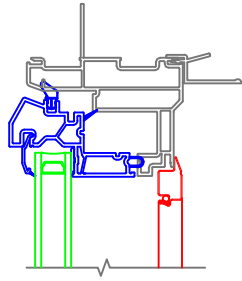
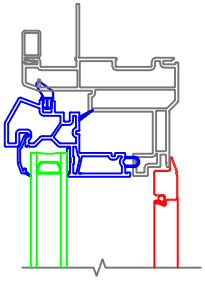

With Applied J-Channel

Without J-Channel
1/2"-5/8"
Drywall Return

3/4"
Drywall Return

Extension Jamb

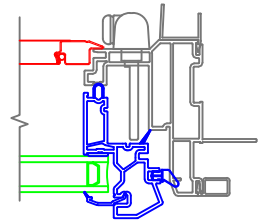
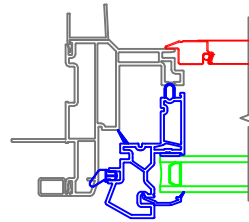
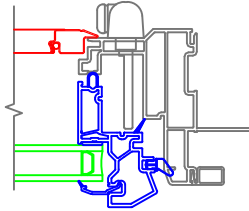
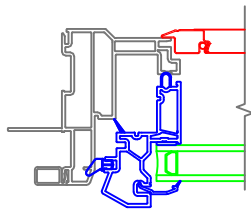

With Applied J-Channel

3/4"
Drywall Return

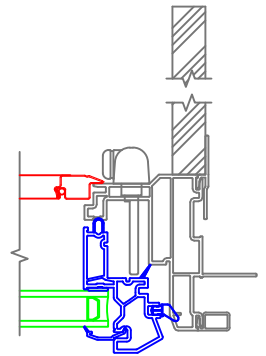
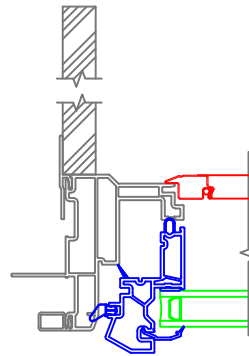
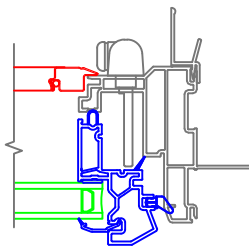
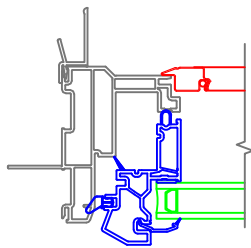

Without J-Channel

1/2"-5/8"
Drywall Return

Extension Jamb

Mathews Brothers
Company

DESCRIPTION:

Walcott New Construction
Casement (Left Hand Vent from Exterior Shown)

"A"

SHEET:

DRAWN BY:

SCALE:

1:4

DATE:

May 10, 2018

DWG NO.:

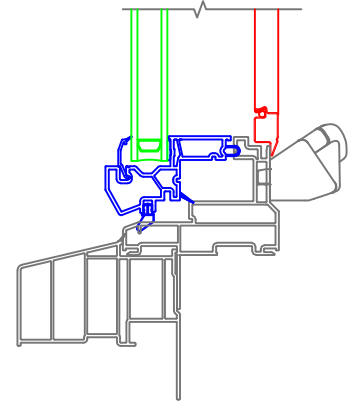
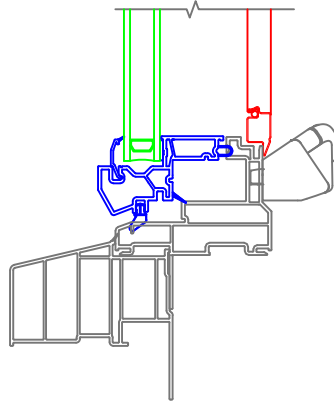
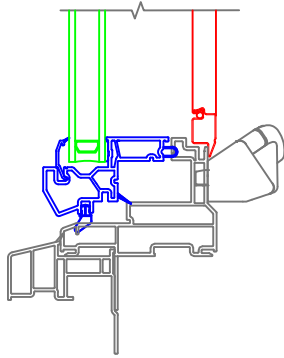
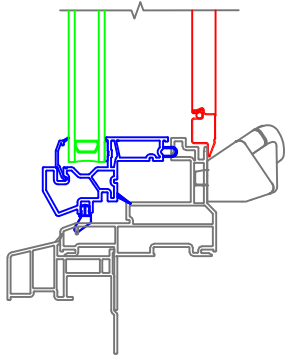
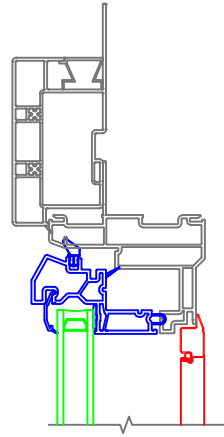
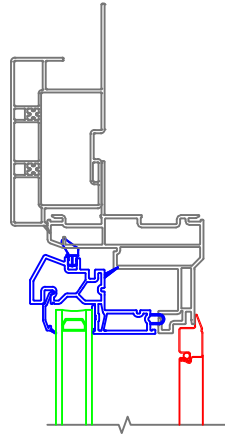
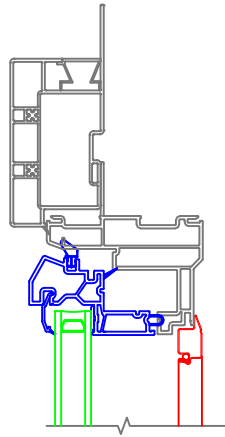
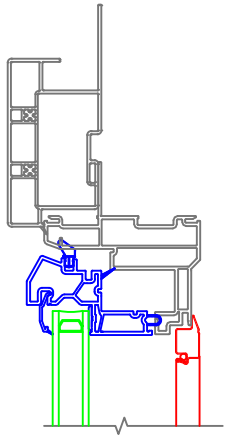

5/4 x 3-1/2 Flat Casing with J-Channel
Standard Sill Nose

5/4 x 3-1/2 Flat Casing without J-Channel
Standard Sill Nose

5/4 x 3-1/2 Flat Casing with J-Channel
Historical Sill Nose

5/4 x 3-1/2 Flat Casing without J-Channel
Historical Sill Nose

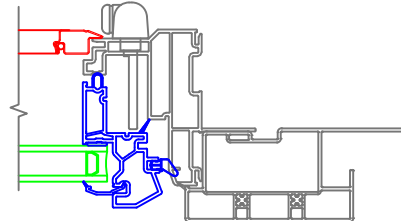
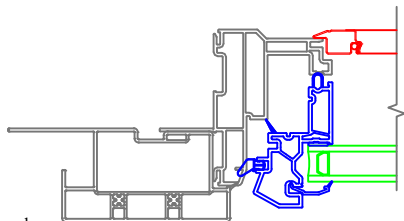

5/4 x 3-1/2 Flat Casing with J-Channel

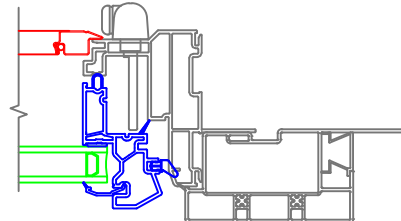
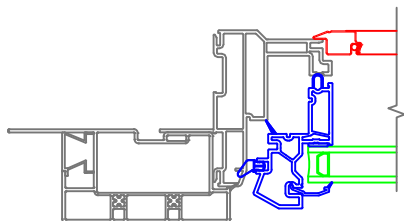

5/4 x 3-1/2 Flat Casing without J-Channel

Mathews Brothers
Company

DESCRIPTION:

Walcott New Construction
Casement (Left Hand Vent from Exterior Shown)

"A"

SHEET:

DRAWN BY:

SCALE:

1:4

DATE:

May 10, 2018

DWG NO.:

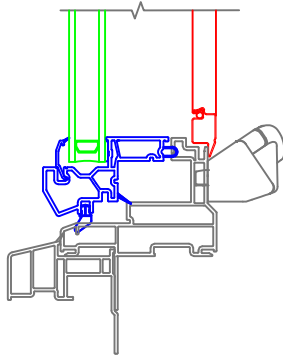
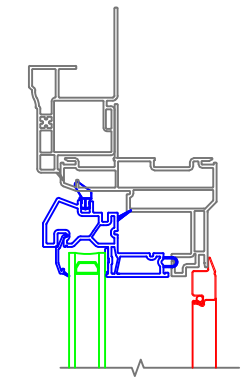

Brickmould Casing with J-Channel
Standard Sill Nose

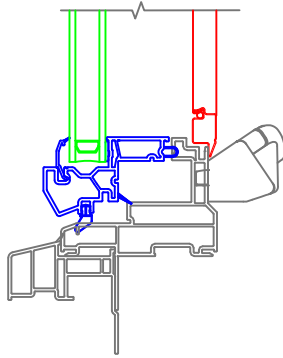
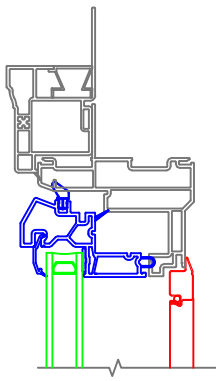

Brickmould Casing without J-Channel
Standard Sill Nose

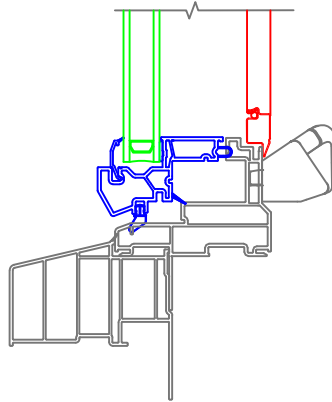
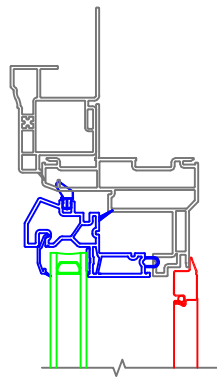

Brickmould Casing with J-Channel
Historical Sill Nose

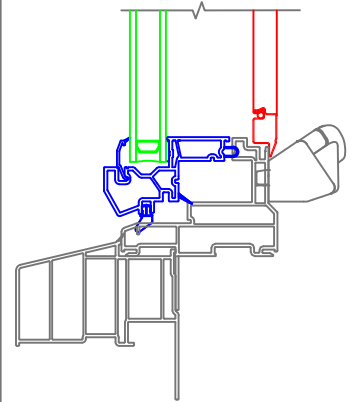
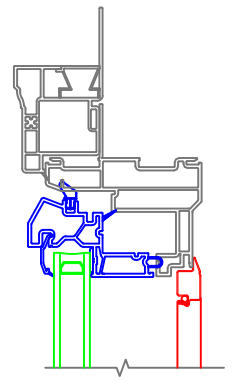

Brickmould Casing without J-Channel
Historical Sill Nose

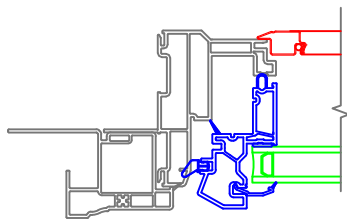

Brickmould Casing with J-Channel

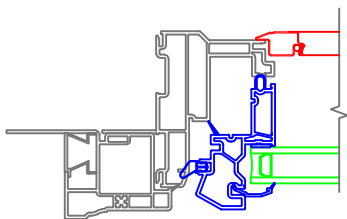
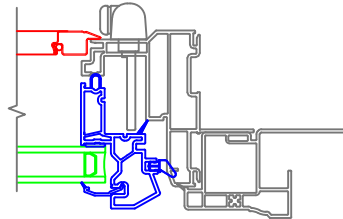

Brickmould Casing without J-Channel

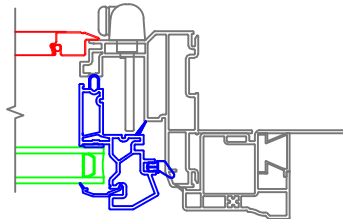

Mathews Brothers
Company

DESCRIPTION:

Walcott New Construction
Casement (Left Hand Vent from Exterior Shown)

"A"

SHEET:

DRAWN BY:

SCALE:

1:4

DATE:

May 10, 2018

DWG NO.:

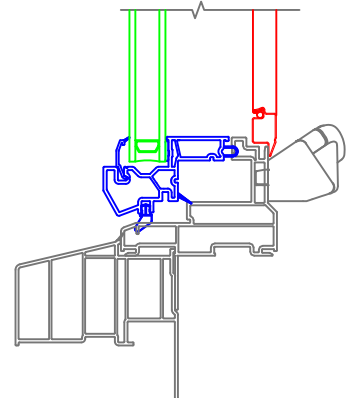
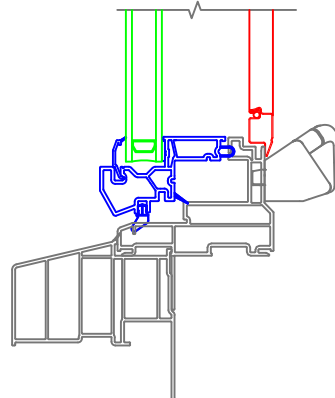
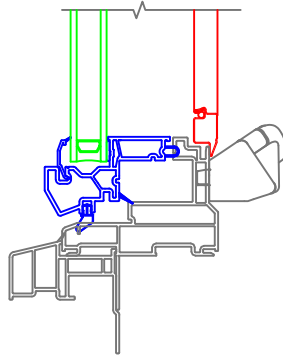
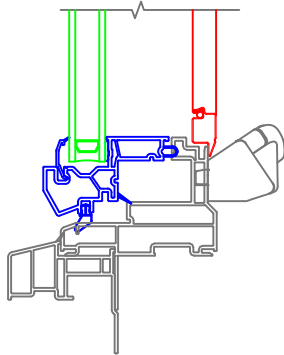
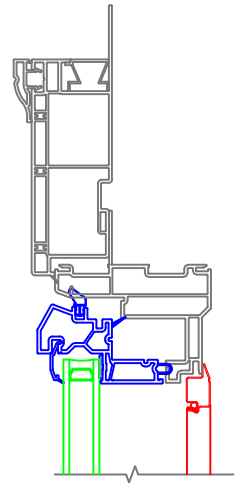
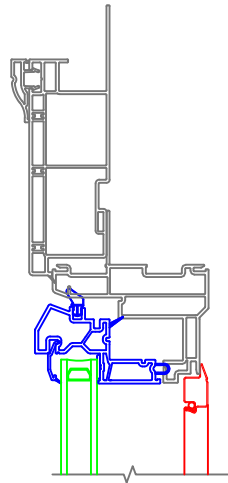
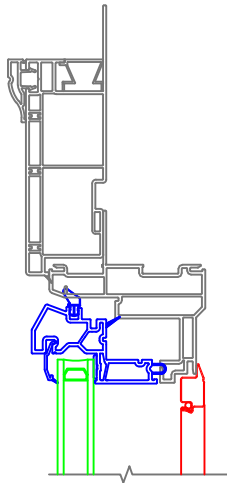
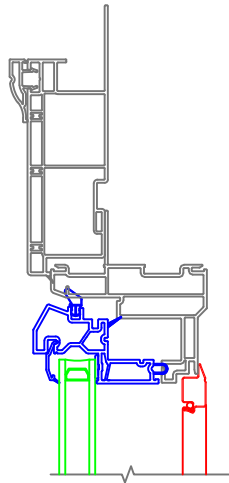

4-1/2 Banded Casing with J-Channel
Standard Sill Nose

4-1/2 Banded Casing without J-Channel
Standard Sill Nose

4-1/2 Banded Casing with J-Channel
Historical Sill Nose

4-1/2 Banded Casing without J-Channel
Historical Sill Nose

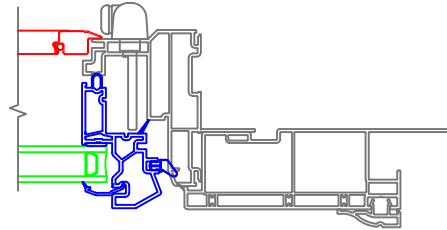
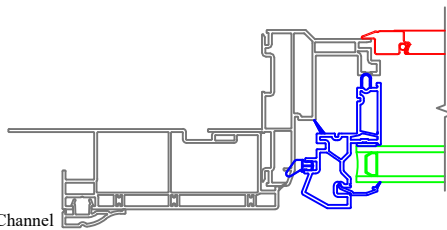

4-1/2 Banded Casing with J-Channel

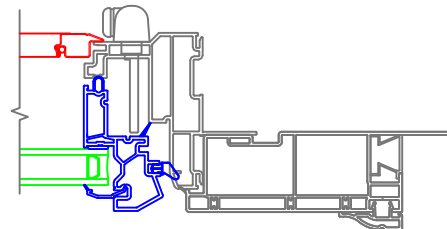
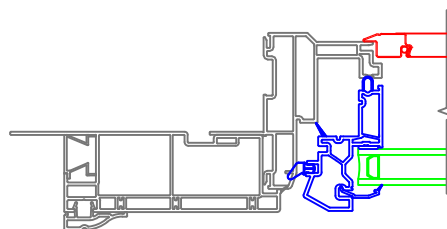

4-1/2 Banded Casing without J-Channel

Mathews Brothers
Company

DESCRIPTION:

Walcott New Construction
Casement (Left Hand Vent from Exterior Shown)

"A"

SHEET:

DRAWN BY:

SCALE:

1:4

DATE:

May 10, 2018

DWG NO.:

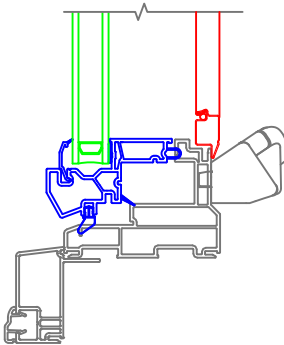
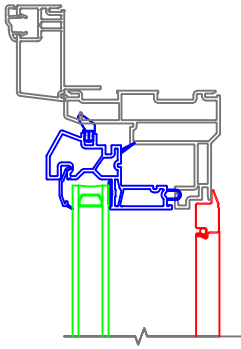

Northern Casing without J-Channel

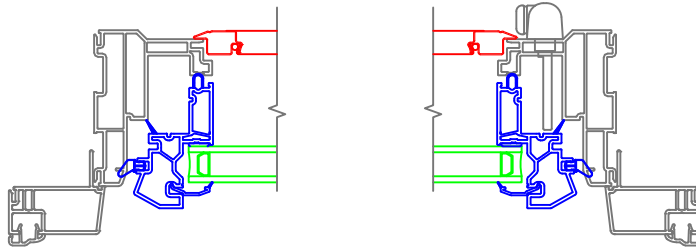

Northern Casing without J-Channel

Mathews Brothers
Company

DESCRIPTION:				
Walcott New Construction Casement (Left Hand Vent from Exterior Shown)				
"A"				DATE: May 10, 2018
SHEET:	DRAWN BY:	SCALE: 1:4		DWG NO.:

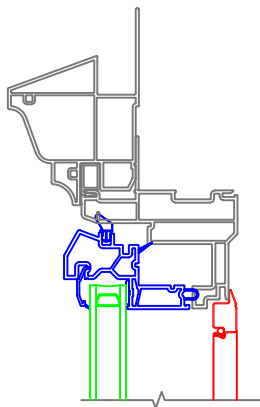

With J-Channel and Crown Crosshead Moulding

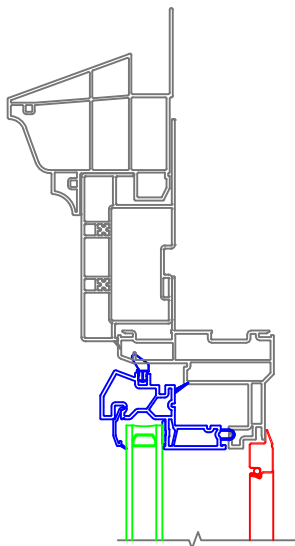

5/4 x 3-1/2 Flat Casing and Crown Crosshead Moulding

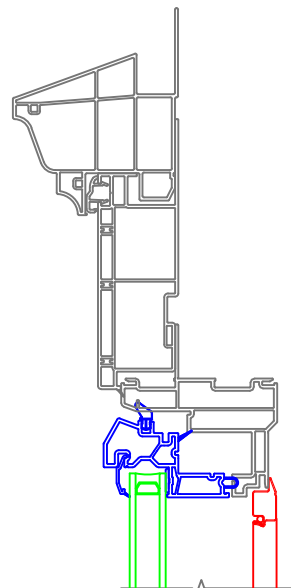

4-1/2 Banded Casing and Crown Crosshead Moulding

Grille in Airspace and Simulated Divided Lite Options

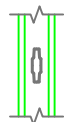

Contour

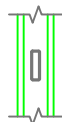

Rectangle, 5/8"



7/8" SDL
with Spacer



7/8" SDL
without Spacer



5/8" SDL
with Spacer



5/8" SDL
without Spacer



5/8" Exterior SDL
with Contour



1-3/8" SDL



2-1/8" SDL

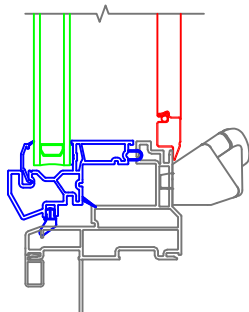

Shown with operator handle in the closed position.

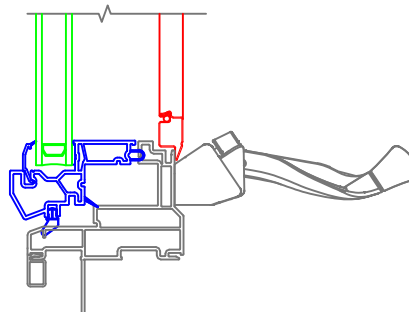

Shown with operator handle in the open position.

Mathews Brothers
Company

DESCRIPTION:

Walcott New Construction
Casement (Left Hand Vent from Exterior Shown)

"A"				DATE: May 10, 2018
SHEET:	DRAWN BY:	SCALE: 1:4	DWG NO.:	